



WORLD NO. 1 IN HYDRAULIC
ELEVATOR TECHNOLOGY

More than **830,000 lifts** worldwide
with **GMV technology**



GREEN LIFT FLUITRONIC MRL

www.gmv.it
www.gmv-india.co.in

4 GOOD REASONS TO CHOOSE GREEN LIFT FLUITRONIC MRL

1

Use of **biodegradable ecological fluid (NO OIL)**

> RESPECT FOR THE ENVIRONMENT

- Use of **Bio-degradable ecological fluid (NO OIL)**
- **Reduced installed power** up to 20% compared to traditional hydraulic systems
- **Reduced consumption** up to 30% compared to traditional hydraulic systems

2

> HIGH QUALITY - more than 810,000 elevators worldwide with GMV technology - which allows the possibility of **WARRANTY EXTENSION UP TO 10 YEARS.** *

An extended warranty means quality and certainty of having spare parts available for 10 years. The 10-year warranty extension ensures that there is no manufacturer reliance. It guarantees maximum efficiency and low cost. The 10-year warranty extension is renewable for another 15 years, so for the entire lifetime of the elevator.

3

> FAST TRACK

(Delivery in 4 to 5 weeks) for Standard configurations, at a very competitive price.

4

> REDUCED SHAFT DIMENSION WITH NO PROJECT LIMIT

- No machine Room
- Short-Pit and Short-Headroom version available



* Conditions Apply



> **GREEN LIFT FLUITRONIC HAS ALSO THE FOLLOWING BENEFITS:**

- **LOW SEISMIC VULNERABILITY:**

No requirement of machine or counterweight suspended masses

- **ELEVATOR COST**

Can save up to 20%

- **CONSTRUCTIVE SIMPLENESS**

- **SAFETY, CONFORT AND MAINTENANCE SAVINGS**

The elevator brain is easy to reach. Machine maintenance can be done without leaving the ground. The total life cost of the elevator can be less up to 30% in 10-years, thanks to warranty extension and constructive simplicity.

- **SPARE PARTS**

All the technical information, spare parts and instruments needed to execute the right maintenance and programming, are available at the market price.

- **EMERGENCY DEVICE**

Return to floor with integrated door opening in case of blackout (ARD)

- **MANUAL EMERGENCY**

Evacuation is possible without auxiliary power (MRL-MC version)

Thanks to Fluitronic Technology, GMV reset the gap between gearless and traditional hydraulic elevator performances, with no economic impact.

CUT THE ANNUAL CONSUMPTION COSTS OF A RESIDENTIAL GEARLESS ELEVATOR

> Green Lift Fluitronic guarantees exceptionally low energy consumption thanks to:

- Dry motors, higher efficiency because they are not subject to viscous fluid friction. Dry motors also allow less fluid heating and auxiliary cooling devices reduction
- NGV electronic valve, which reset the use of heat exchange devices, avoid from using valve and oil heating resistors
- Also the ETC system, together with mechanical valve 3010, eliminates the use of valve and oil heating resistors
- No need of Frequency Converter, which allows low power consumption in standby mode (unlike gearless electrical systems that cannot power off the Frequency Converter during stand-by mode)
- Energy Consumption only uphill direction, as well as all hydraulic systems.
- Power Supply Size reduced up to 6 kW (450 kg capacity), with the new NRGs power unit (Energy Saving)

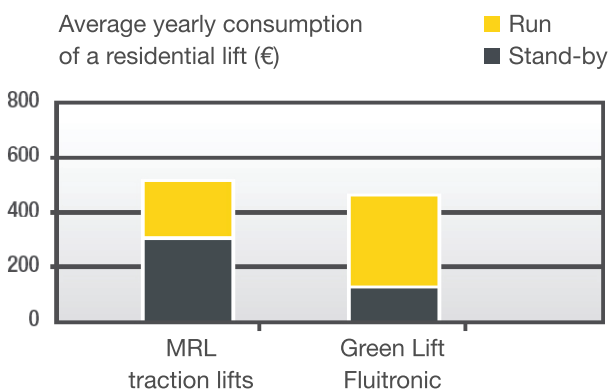

As per above example, the annual cost of a Green Lift Fluitronic elevator doesn't exceed 300-400€ on average.

COMFORT AND HIGH PERFORMANCES



> NGV ELECTRONIC VALVE

NGV electronic valve with digital technology allows high ride performance, with gradual and undetected acceleration and deceleration and accurate floor levelling.



> ETC ELECTRONIC SYSTEM

ETC (Electronic Temperature Control) system, together with the 3010 Valve, is able to optimize the speed reduction curves, decreasing fly-time, ensuring a better traffic management compared to a traditional hydraulic elevator, with an average speed of 0,8 m/s.

Both NGV valve and ETC device respects EN81.20 and EN81.70, concerning levelling precision of ± 10 mm when reaching landing floors.

GREEN LIFT FLUITRONIC ANTISEISMIC VERSION

> Main characteristics of the GLF Antiseismic version:

- Car frame with appropriate protections to prevent guide-shoes escaping during an earthquake
- Guide Dimensions that takes into account the inertial forces created by the maximum horizontal acceleration (A_h)
- Car doors with additional door-lock to prevent from accidental opening
- Battery power supply that allows emergency operation in case of power failure: system stops and reaches, at reduced speed, the destination floor, opens the doors and remains out of service with the doors in open position.

- > **According to EN81.77 norm**, the elevator must be designed and manufactured considering the seismic grade of the area where it will be installed. The constructor company, must define, for any new building, the maximum horizontal acceleration (A_h) that can occur during a seismic event, depending on the area. The design criteria of the building must be adapted to the seismic risk level of the construction area. According to EN81.77, all lift design criteria must also take into account the acceleration value (A_h).

In every areas where new buildings must be designed in compliance with criteria appropriate to the level of seismic risk, the elevators should respect the EN81.77. Elevators which respect EN81.77 allow to maintain the facilities availability and avoid from wasting money to replace elevators inside buildings that resisted structurally to the earthquake.

Hydraulic systems require less intervention to comply the EN81.77. Therefore, hydraulic systems, which respect EN81.77 have a competitive advantage in terms of construction and price compared to electrical units conforming to the same Law.

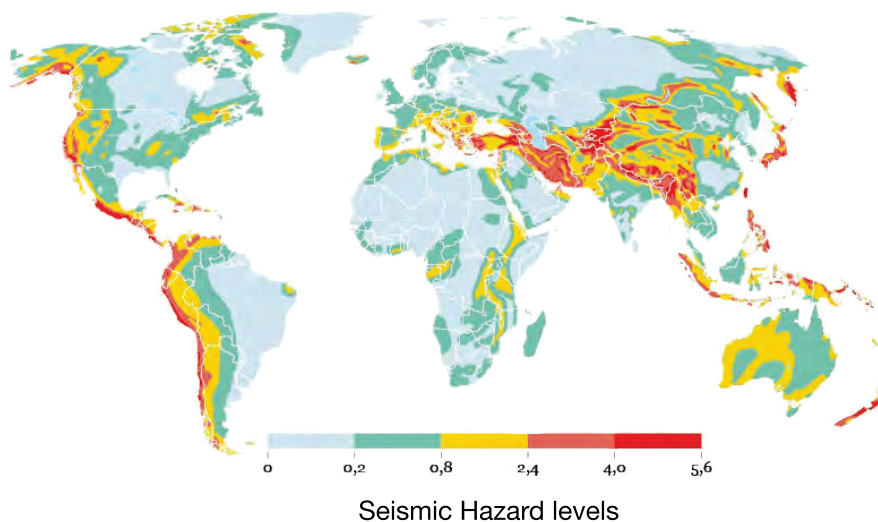



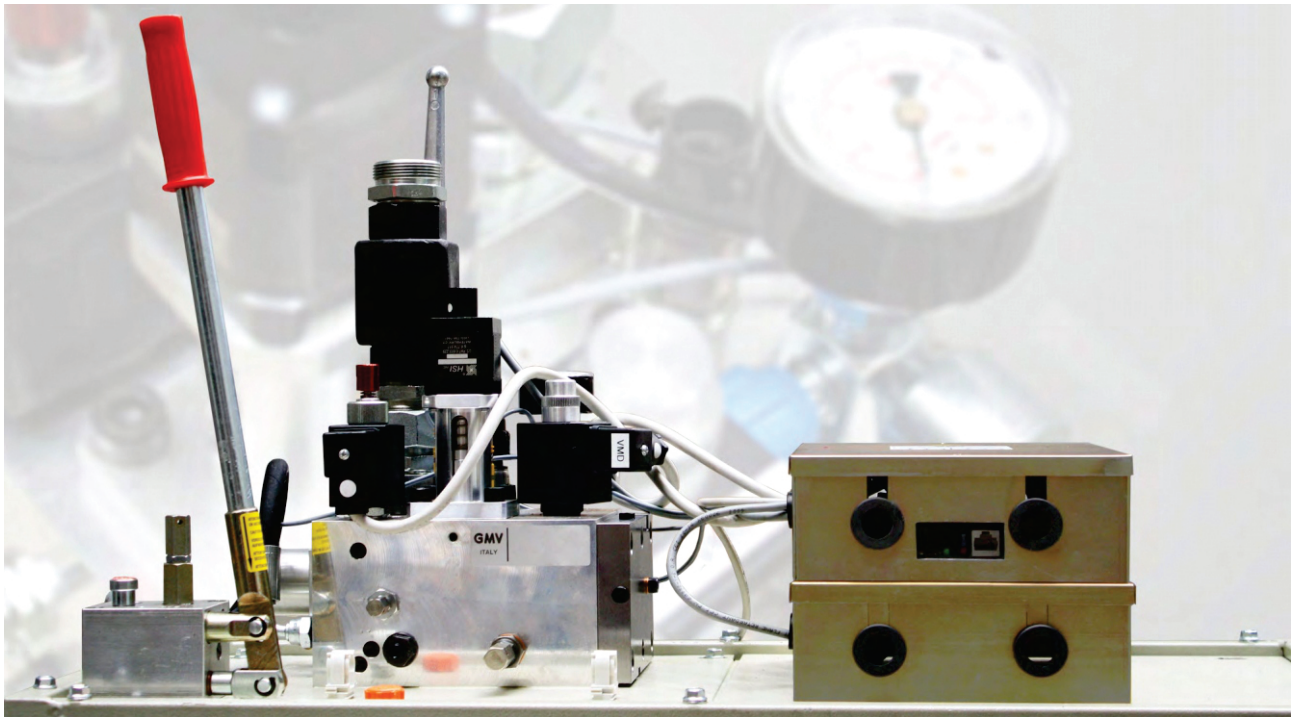

NGV electronic valve

TECHNICAL FEATURES	
Drive	Hydraulic
Machine	Dry or with submerged motor power unit
Description	<p>Hydraulic lift with indirect action (2: 1) in versions:</p> <ul style="list-style-type: none"> • MRL-T with power unit and control panel in the lift shaft and remote controls accessible from outside the shaft • MRL-T 2 with power unit in the lift shaft and control panel in cabinet outside the shaft (or embedded in the shaft) next to a door, preferably on the lower floor • MRL-MC with power unit and control panel in cabinet out of the lift shaft
Machine room	Not required
Intended use	Residential buildings, offices, hotels, public and private buildings
Conformity to Directives and Standards	<p>Lift Directive 2014/33/UE; Electromagnet Compatibility Directive 2014/30/UE. Harmonized Norm: EN 81-20 – EN 81-50 (Safety Rules for Elevators); EN 81.28 (Elevator Tele-alarm). On option: EN 81.70 (Architectural Barriers Removal); EN 81.58 (Fire Resistance Doors); EN 81.21 (Short-pit and/or short-headroom); EN 81.73 (Safety rules in case of fire presence)</p>
Safety devices	<ul style="list-style-type: none"> • SAFETY GEAR: <ul style="list-style-type: none"> - INSTANTANEOUS - PROGRESSIVE • RUPTURE VALVE GMV - VC3006/B 1"1/4 - 1"1/2 • DOOR LOCK DEVICE: • MECHANICAL DEVICE OF PROTECTION IN THE PIT: mechanical stop operated from the outside of the shaft, equipped with electrical device to control the position, which ensures in the pit the spaces needed for survival, maintenance and exit
Electric Components	<ul style="list-style-type: none"> • Control panel model NEOS10+ with microprocessor • Automatic Push-Button (APB) / Up Button / Down Button – Up/Down collective • Emergency lowering: UPS integrated in controller (ARD)
Shaft type	Concrete / Brick / Metal structure

TMC CABIN

(Tailor Made Cabin)

> **GMV lifts** got a tailor-made cabin, customizable, solid and light, ideal for low energy consumption lifts. Simplified assembly. Cabin walls, as well as car fixtures, could be customized on owners' desires and are easily **replaceable** allowing fast restyling. Cabins with **panoramic walls** are available. We can supply doors w/o door jambs, to allow maximum freedom in the realization of the entrances.

CEILING

Stainless Steel with LED lights (spotlight or ceiling light).

STRUCTURE AND ANGULARS

Made of pre-painted (polimod) dark gray (code 205) or stainless steel scotch brite (code 301).

DOORS

Pre-painted or stainless steel or glass car and landing doors, with the same choice of colours and finishes available for cabin walls, see page 9. Fire resistance doors according to EN 81.58, E60 - E120 - E130 - E160 - E190 - E1120. Possibility of slim sill.

FIXTURES

It's possible to choose between standard solution, black panel with or without TFT display (5,00" in cabin and 2,8" on landing floors) or Stainless Steel panel, surface, with or without LCD display (5.25" in cabin and 2.8" on landing floors).

HANDRAIL

Stainless Steel Ø 30mm according EN 81.70.

FLOOR

PVC anti-slip or rubber stamp.

CABIN WALLS

It's possible to choose between standard solutions, described on page 9, or a wide range of combination of colours and materials, such as Plastic Laminate, Stainless Steel and Glass..

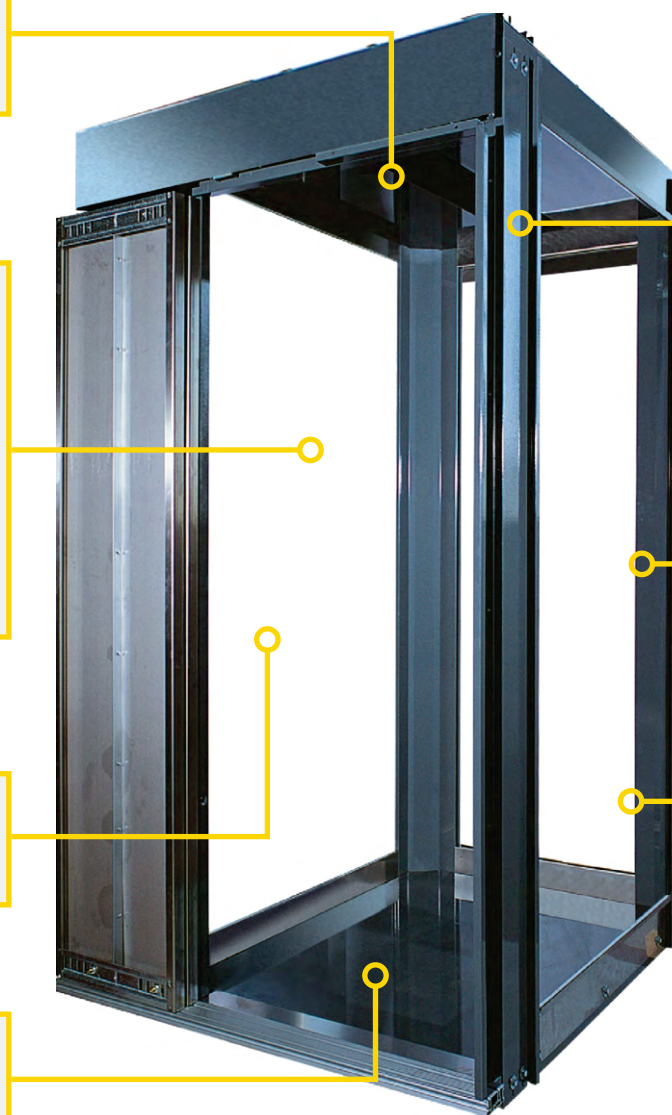

Cabin walls ▲
 Car doors ■
 Landing doors ●

FACED ▲

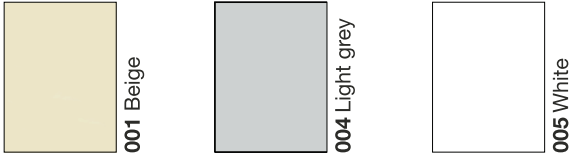

STAINLESS STEEL ▲ ■ ●

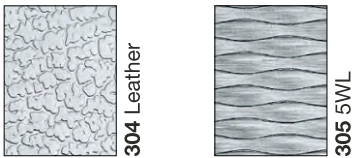

GLASS ▲ ■ ●

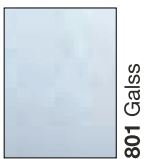

Floor coatings

PVC

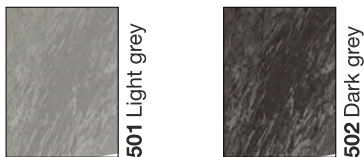

**TMC CABIN
 COLORS & MATERIALS**

PRE-PAINTED SHEET METAL (Polimod) ▲ ■ ●

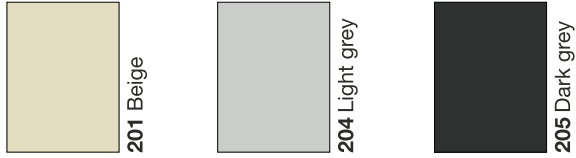

PLASTIC LAMINATED ▲

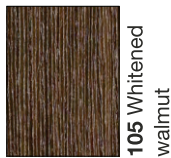
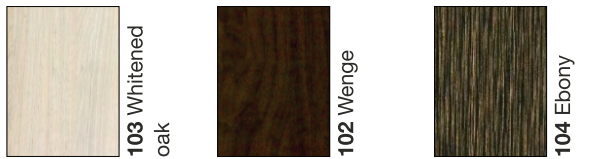
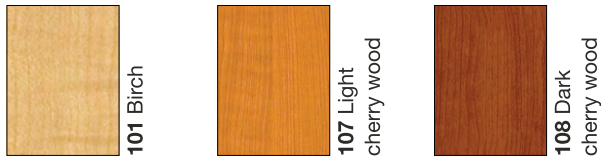
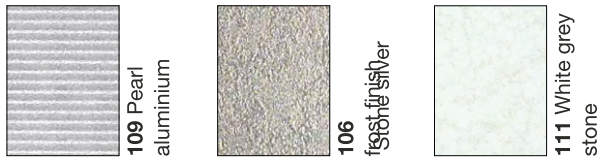
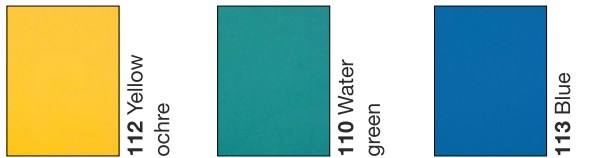

DOTTED RUBBER



MRL-T VERSION

Everything inside the shaft. Ideal solution when space reduction is mandatory. Remote controls accessible from outside the shaft.

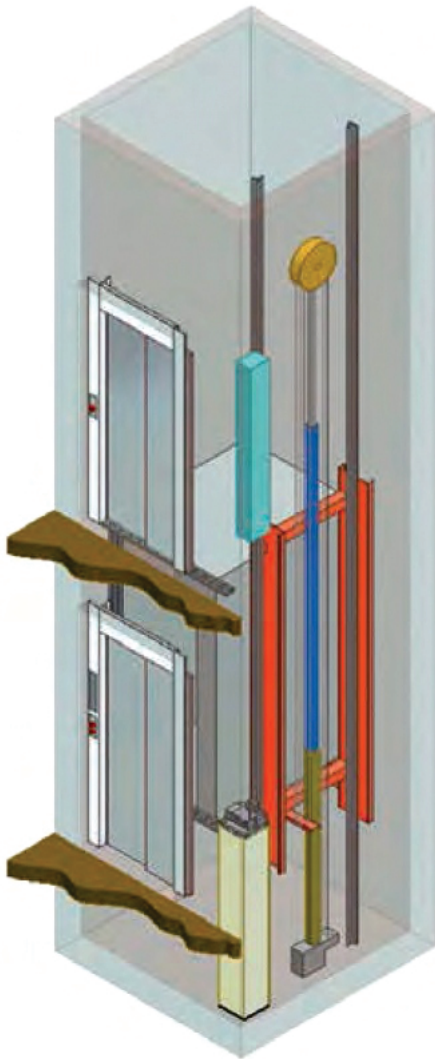

SHAFT SECTION

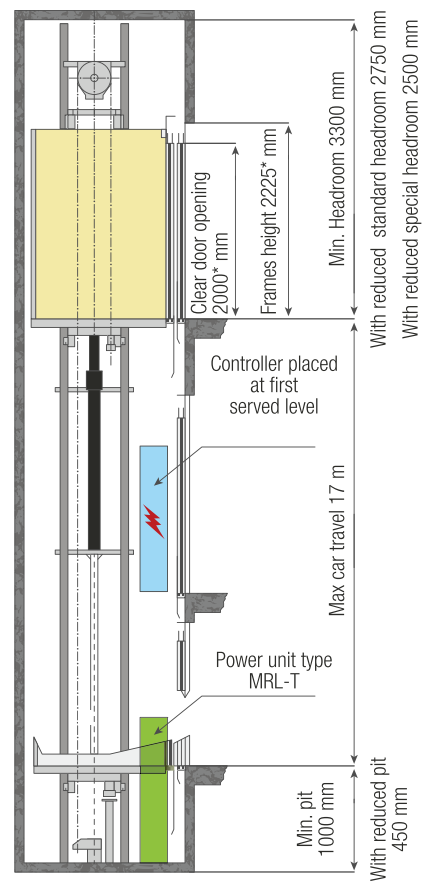

(*Clear door opening 2100 mm with frames height 2325 mm, on request.

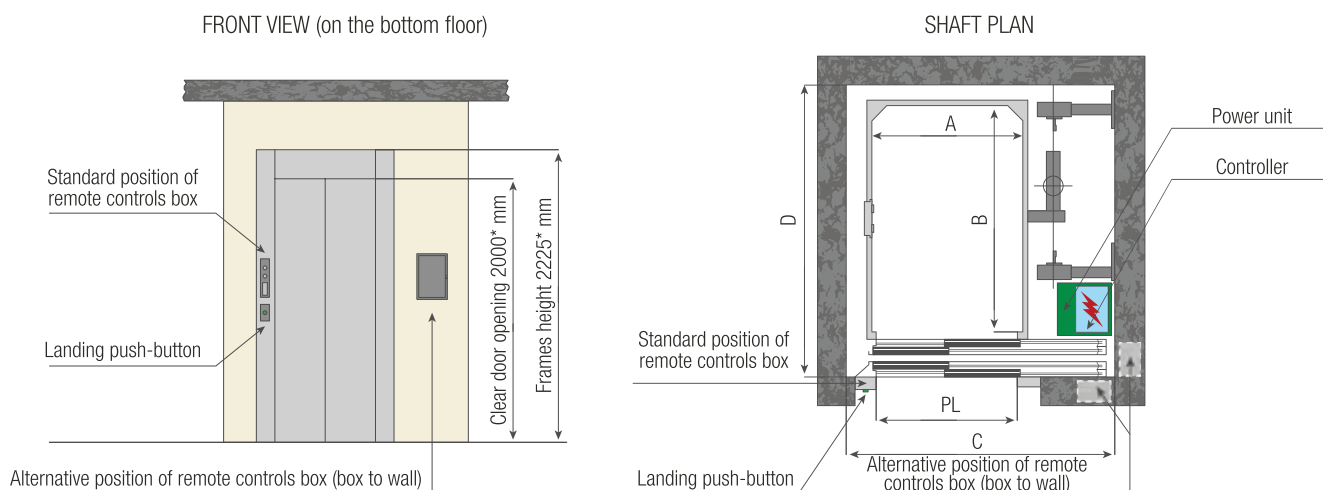

(*)Clear door opening 2100 mm with frames height 2325 mm, on request.

STANDARD DIMENSIONS

Payload [kg]	No. of passengers	Car dimensions [mm]		Entrances [No.]	Clear door opening [mm]		Min. shaft dimensions with doors opening at side [mm]	
		A (mm)	B (mm)		PL (mm)	C (mm)	D (mm)	
350	4	800	1200	1	750	1350	1550	
450	6	950	1300	1	800/850/900	1500/1500/1550	1650	
				2 opposite	800/850/900	1500/1500/1550	1840	
		1000 (*)	1250 (*)	1	800/850/900	1550	1600	
				2 opposite	800/850/900	1550	1790	
		1000 (*)	1300 (*)	1	800/850/900	1550	1650	
				2 opposite	800/850/900	1550	1840	
630	8	1100 (*)	1400 (*)	1	800/900	1650	1750	
				2 opposite	800/900	1650	1940	

Standard speed [m/s]	Standard speeds for each payload								
	Upward	0,40		0,52		0,62		0,86	
	Downward	0,40	0,48(**)	0,52	0,62 (**)	0,62	0,74 (**)	0,86	1,00 (**)

Non-contractual information subject to conditions of use. Shaft dimensions refer to orthogonal spaces. The measures listed in the table are approximate. For feasibility of any solution, not present in the table, please contact GMV Sales Office. Minimum shaft width for lifts in accordance with EN 81.21 may vary slightly with respect to the standard indicated in the table. The cabin dimensions shown in the table with an asterisk are in accordance with EN 81.70. For any cabin dimensions not shown in the table, please contact GMV Sales Office. For doors with central openings, please contact GMV sales office. Available with reduced pit and/or head room, with doors opening at side. (***) Possibility of downward speed different from upward speed only with electronic valve

MRL-T 2 VERSION

Power unit in the lift shaft and control panel in cabinet outside the shaft (or embedded in the shaft) next to a door, preferably on the lower floor.

FRONT VIEW

(floor with cabinet containing the control panel)

WITH CABINET leaning AGAINST THE WALL OF THE LIFT SHAFT

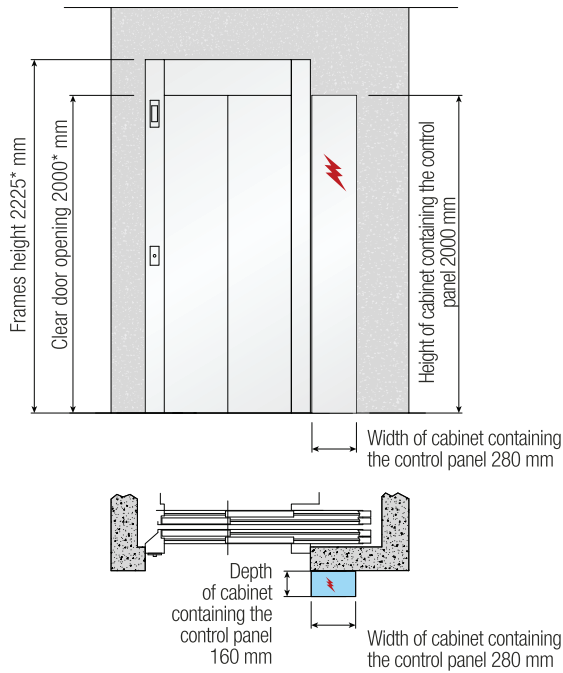

FRONT VIEW

(floor with cabinet containing the control panel)

WITH CABINET EMBEDDED IN THE LIFT SHAFT

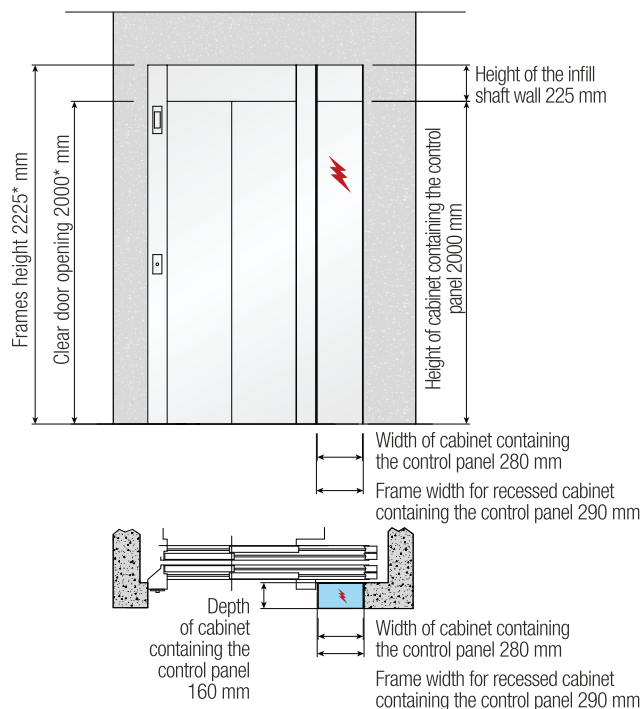

SHAFT SECTION

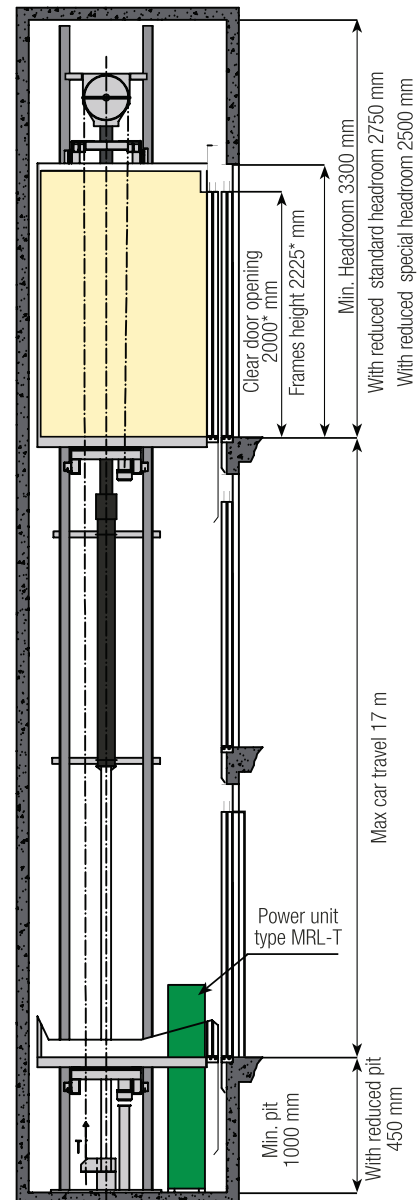

(*) Clear door opening 2100 mm with frames height 2325 mm, on request.

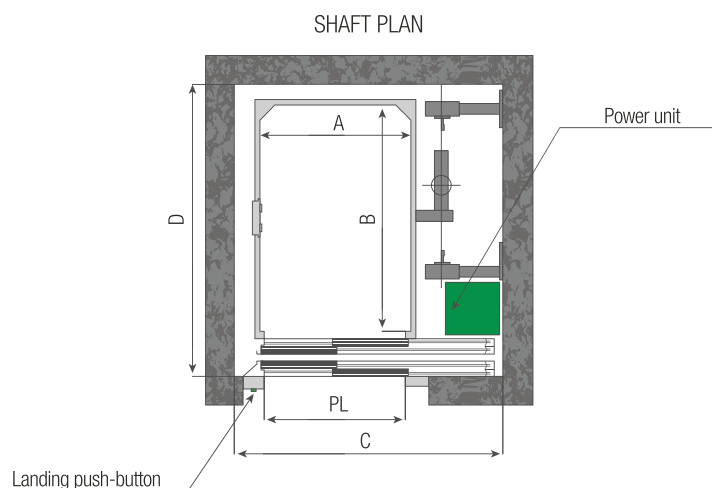

STANDARD DIMENSIONS

Payload [kg]	No. of passengers	Car dimensions [mm]		Entrances [No.]	Clear door opening [mm]	Min. shaft dimensions with doors opening at side [mm]	
		A (mm)	B (mm)		PL (mm)	C (mm)	D (mm)
350	4	800	1200	1	750	1350	1550
450	6	950	1300	1	800/850/900	1500/1500/1550	1650
				2 opposite	800/850/900	1500/1500/1550	1840
		1000 (*)	1250 (*)	1	800/850/900	1550	1600
				2 opposite	800/850/900	1550	1790
		1000 (*)	1300 (*)	1	800/850/900	1550	1650
				2 opposite	800/850/900	1550	1840
630	8	1100 (*)	1400 (*)	1	800/900	1650	1750
				2 opposite	800/900	1650	1940

Standard speed [m/s]	Standard speeds for each payload								
	Upward	0,40		0,52		0,62		0,86	
	Downward	0,40	0,48(**)	0,52	0,62 (**)	0,62	0,74 (**)	0,86	1,00 (**)

Non-contractual information subject to conditions of use. Shaft dimensions refer to orthogonal spaces. The measures listed in the table are approximate. For feasibility of any solution, not present in the table, please contact GMV Sales Office. Minimum shaft width for lifts in accordance with EN 81.21 may vary slightly with respect to the standard indicated in the table. The cabin dimensions shown in the table with an asterisk are in accordance with EN 81.70. For any cabin dimensions not shown in the table, please contact GMV Sales Office. For doors with central openings, please contact GMV sales office. Available with reduced pit and/or head room, with doors opening at side. (***) Possibility of downward speed different from upward speed only with electronic valve

MRL-MC VERSION

Control panel and power unit (traditional or Dry-Motor version) are placed in a cabinet close to machine room, typically at lower floor, to simplify maintenance and technical intervention.

This is the cheapest MRL solution.

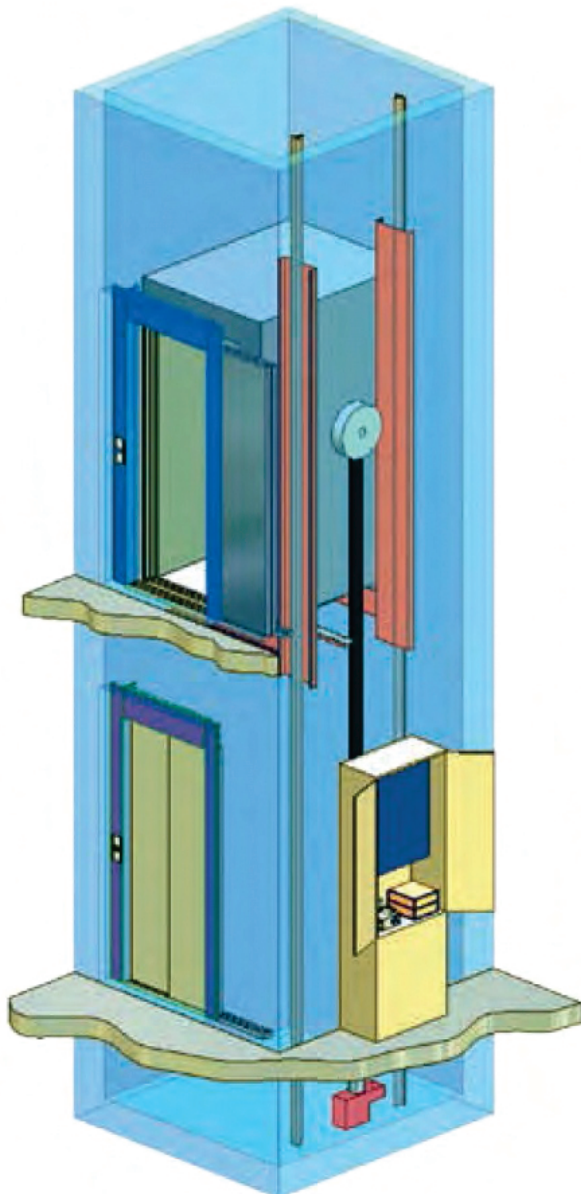

SHAFT SECTION

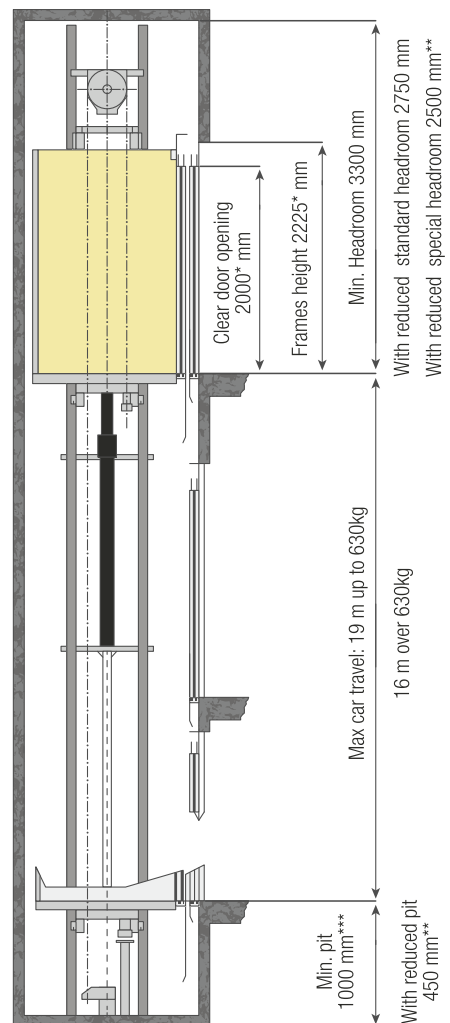

(*) Clear door opening 2100 mm with frames height 2325 mm, on request.

(**) For lifts payload higher than 630 kg: min. reduced pit 500 mm - min. reduced headroom 2800 mm

(***) For lifts payload up to 630 kg min. pit 1000 mm; for lifts payload higher than 630 kg min. pit 1100 mm.

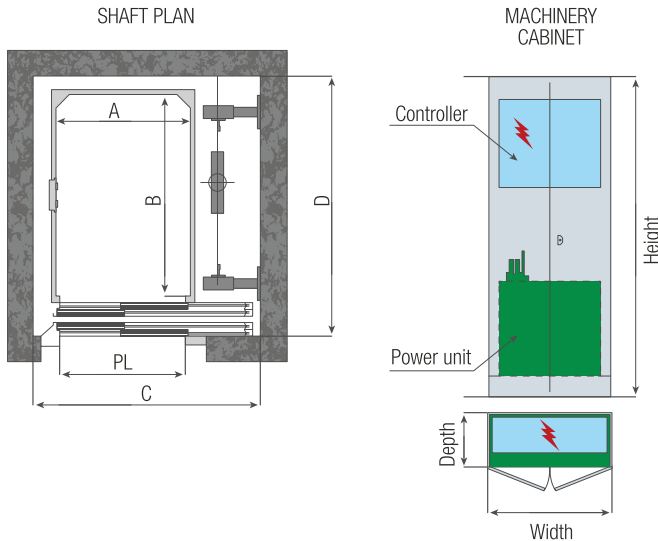

MACHINERY CABINET				
Cabinet type	Dimensions [mm]			Payload [kg]
	Width	Depth	Height	
C	870	400	2100	320/630
C-EN 81.20	870	400	2100	320/630
F	1000	650	2100	900/1025

STANDARD DIMENSIONS

Payload [kg]	No. of passengers	Car dimensions [mm]		Entrances [No.]	Clear door opening [mm]		Min. shaft dimensions with doors opening at side [mm]	
		A (mm)	B (mm)		PL (mm)	C (mm)	D (mm)	
320	4	900	1000	1	700/800	1350/1400	1350	
350	4	800	1200	1	750	1350	1550	
				2 opposite	750	1350	1740	
450	6	950	1300	1	800/850/900	1400/1500/1550	1650	
				2 opposite	800/850/900	1400/1500/1550	1840	
		1100	1100	1	800/850/900	1550	1450	
				2 opposite	800/850/900	1550	1640	
		1000 (*)	1250 (*)	1	800/850/900	1450/1500/1550	1600	
				2 opposite	800/850/900	1450/1500/1550	1790	
1000 (*)	1300 (*)	1	800/850/900	1450/1500/1550	1650			
		2 opposite	800/850/900	1450/1500/1550	1840			
630	8	1100 (*)	1400 (*)	1	800/900	1550	1750	
				2 opposite	800/900	1550	1940	
900	12	1400 (*)	1500 (*)	1	900/1000	1900	1850	
				2 opposite	900/1000	1900	2040	
1000	13	1100 (*)	2110 (*)	1	900/1000	1600/1700	2450	
				2 opposite	900/1000	1600/1700	2650	

Standard speed [m/s]	Standard speeds for each payload								
	Upward	0,40		0,52		0,62		0,86	
	Downward	0,40	0,48(**)	0,52	0,62 (**)	0,62	0,74 (**)	0,86	1,00 (**)

Non-contractual information subject to conditions of use. Shaft dimensions refer to orthogonal spaces. The measures listed in the table are approximate. For feasibility of any solution, not present in the table, please contact GMV Sales Office. Minimum shaft width for lifts in accordance with EN 81.21 may vary slightly with respect to the standard indicated in the table. The cabin dimensions shown in the table with an asterisk are in accordance with EN 81.70. For any cabin dimensions not shown in the table, please contact GMV Sales Office. For doors with central openings, please contact GMV sales office. Available with reduced pit and/or head room, with doors opening at side. (***) Possibility of downward speed different from upward speed only with electronic valve



GMV INDIA PRIVATE LIMITED

Office:

201, 2nd Floor – LEONARDO OFFICE,

Building type A,

Hiranandani Estate,

Ghodbunder Road,

Thane (W) – 400607

Tel.: +91 22 41005236

Tel.: +91 7506336730

e-mail: info@gmv-india.co.in

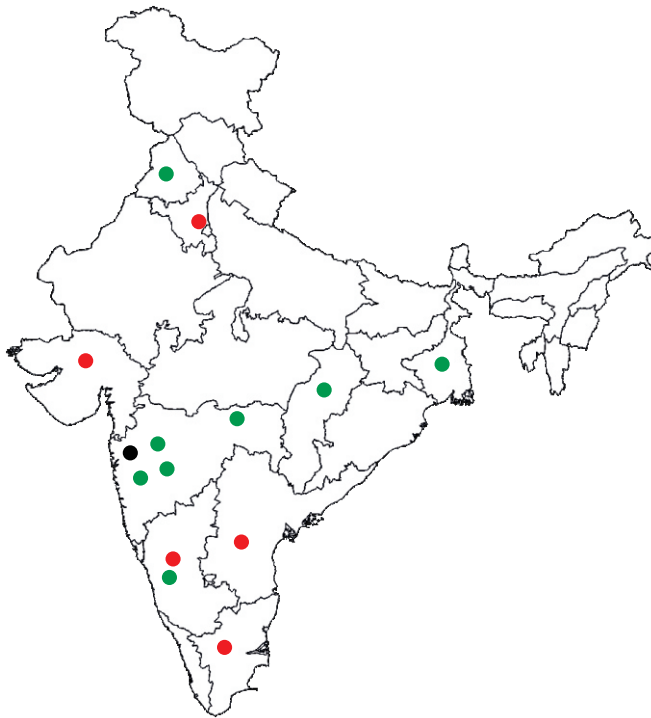

For More details

Please Log On to.
www.gmv-india.co.in

GMV India's Network

- Head Office in Mumbai
- Glocal Partners
- Distributors

GMV worldwide



GMV's quality systems are certified. Furthermore, we have introduced the "6 sigma" concept as a total quality philosophy, up to the complete testing of the products.

This document is for information purposes only. We reserve the right to modify at any time the reported specifications, without notice. We recommend that you view actual samples of car finishes, as there may be slight differences to those illustrated in the brochure.